



Client \_\_\_\_\_ Quantity \_\_\_\_\_  
 Project \_\_\_\_\_ Position \_\_\_\_\_

## Vision Industry W35K F

**Model:** W35KFR

**Cod:** W81110112001

### Technical data

<b>Max capacity:</b>	1 trolley GN1/1, EN60x40
<b>Temperature range:</b>	-40°+65°C
<b>Refrigerant unit:</b>	Remote
<b>Yield +90 / +3:</b>	100 Kg
<b>Yield +90 / -18:</b>	80 Kg
<b>Cooling gas:</b>	R404/R452
<b>Defrost:</b>	Forced air
<b>Valve:</b>	Electronic expansion valve
<b>Dimensions:</b>	1230×1200×2510 mm
<b>Packing dimensions:</b>	2755×1730×1690 mm
<b>Gross weight:</b>	340 Kg
<b>Voltage:</b>	400-415 V - 50-60 Hz
<b>Total rate:</b>	2170 W
<b>Absorbed Current:</b>	8,16 A
<b>Cooling capacity:</b>	11210 W*
<b>*:</b>	Evap. -10°C Cond. +45°C

### Features

<b>Functions:</b>	Blast chilling, shock freezing, thawing, proving and retarder prover, holding, steam sanitizing, manualcycle
<b>Control:</b>	7" touch screen display with USB port
<b>Door gasket:</b>	Magnetic, triple chamber and easily replaceable
<b>Core probe:</b>	Needle probe with 1 reading point, quick-release and easily replaceable
<b>Insulation:</b>	100 mm thickness - CFC/HCFC free
<b>Exterior/interior finishing:</b>	Internal and external in "linen canvas" steel
<b>Inner corners:</b>	Rounded base 20 mm
<b>Handle:</b>	In AISI 304 stainless steel

### Remote unit technical data

<b>Voltage:</b>	400-415 V 3N - 50 Hz
<b>Cooling gas:</b>	R404-R452a
<b>Gross weight:</b>	187 Kg
<b>Dimensions:</b>	1110×785×626 mm
<b>Cooling capacity:</b>	Evap. -10°C Cond. +45°C

**COSMO - wi-fi control**

Cosmo è l'innovativa tecnologia wi-fi che permette di connettere e monitorare costantemente da smartphone l'abbattitore VISION. VISION può essere anche un Cosmo hub e consentire la supervisione remota di tutti gli apparecchi Coldline a lui collegati. Dall'app Cosmo potrai controllare in tempo reale le condizioni di funzionamento di ogni macchina e ricevere alert in caso di funzionamento anomalo. Cosmo confronta costantemente le prestazioni dell'apparecchio con quelle ideali e, in caso di differenze significative, suggerisce la manutenzione necessaria. Il software VISION può ricevere gli aggiornamenti periodici rilasciati, con le più recenti funzionalità sviluppate.



**Technical draw**

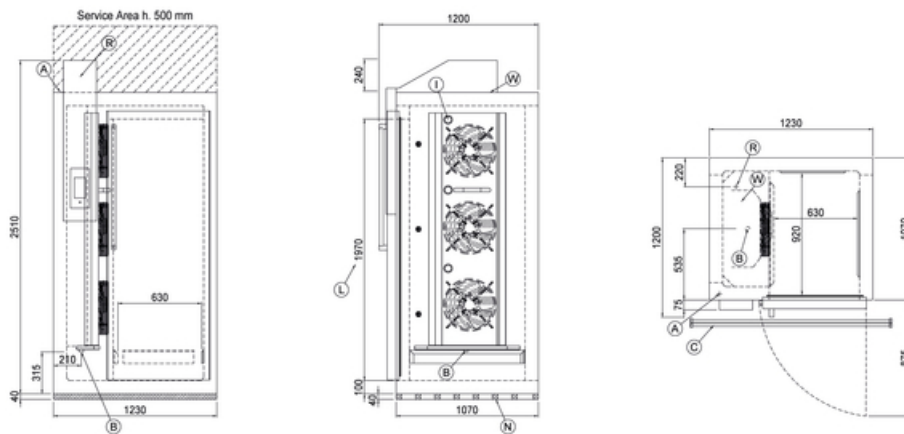

- A:** Power supply cable outlet
- C:** Floor grid for condensate drainage
- L:** Door clear opening dimension

- B:** Condensation water drain
- I:** Internal led lighting
- N:** PVC ventilation profiles

In order to constantly offer the best possible products we reserve the right to make changes on technical specifications without incurring any obligation for equipment previously or subsequently sold.